



User's Manual

SUN-FOSC-ZT804 Series

Fiber Optic Splice Closure

English

Table: SUN-UM-CM-FOSC004

Version: A/0

*All the trademarks mentioned in this manual are registered property of Sun Telecom.
The right to interpret this manual is reserved by Sun Telecom.*

1. Scope of application

This Installation Manual is suit for the Fiber Optic Splice Closure (Hereafter abbreviated as FOSC), as the guidance of proper installation. The scope of application is: aerial, underground, pipeline, handhole. The ambient temperature ranges from -40 to 65°C.

2. Applicable temperature

- -1~+45°C (Temperature for operation)
- -50~+70°C (Temperature for storage and transportation)
- -40~+65°C (The ambient temperature ranges)

3. Stripping fiber cable

when branch cable stripping, should put the length of the fiber optic cable skin peeled off as about 1200 mm, Reserve reinforced core in 60 mm length and cut off the unnecessary ones. See figure 1

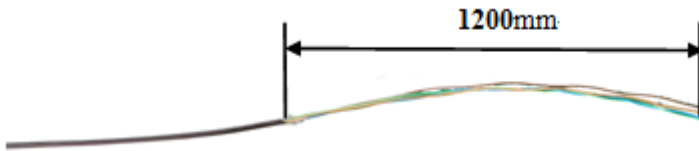

Figure 1

4. Fixing fiber cable.

4.1 Wind 2 layers of insulation tape on protective coat of fiber core for protection. Meanwhile, get rid of the stuffing to separate fiber core and clean them. Form a ring with the diameter of 100mm or so and fix it on the fiber cable temporarily by adhesive tape. Reserve reinforced core in 50mm length and cut off the unnecessary ones.

Fixed cable and reinforced core according to the picture below. See figure 2

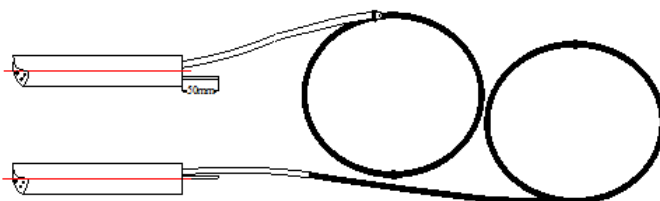

Figure 2

4.2 Fixed cable and reinforced core according to the picture below. See figure 3



Figure 3

4.3 Splice fibers, install heat shrinkable protective sleeve

See figure 4 follow user manual of fusion splicing machine to splice fiber cores. When having completed splicing the fibers, the first fiber ring should be housed on the farthest side of FOST, the remaining fiber should be winded, forming a ring with diameter not less than 80mm. then put it into FOST (Fiber Optic Splice Tray).together with heat shrinkable sleeve for splice protection.

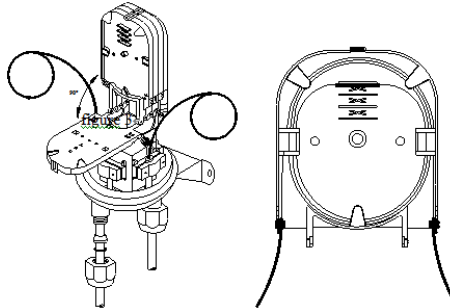

Figure 4

4.4 Check up comprehensively

To ensure the technical requirements, the following instructions must be followed:

- Fibers with protective coat are fixed with nylon tie at the entrance of FOST.
- Grommet should be pressed from inside to outside in order to properly install FOST.
- If there are fibers with protective coat reserved, wind it into the fiber holding tray.

- Check whether the internal tighteners and reinforced core are well tightened.
- Check whether gasket ring is installed neatly and smoothly without any breakage. If not, level it up with seal tape.

Important issues: If any problems occur, they should be solved right away.
See figure 5

5. Assemble FOSC housing

5.1 Put desiccant into FOSC

5.2 Put FOSC cover on base directly.

5.3 Install plastic hoop between FOSC cover and the base, tighten hoop locking system, which is to be fixed by hoop fixing bolt then.

5.4 All nuts (plastic ones) of base need to be re-tightened once more.

6. The installation and fixed of FOSC

6.1 Pole application: Fix metal hoop and transom to the pole. Please refer to figure 6

6.2 Wall mounting application: Fix the bracket on the wall with the bolt. (Metal hoop is not required.) See figure 7

6.3 Underground application: Metal hoop is not required wall accessories.

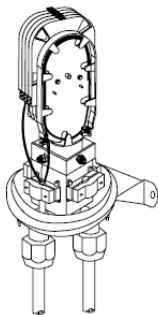

Figure 5

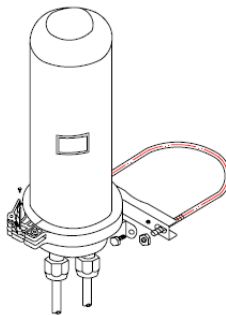

Figure 6

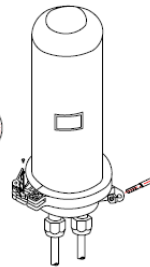

Figure 7

SHANGHAI SUN TELECOMMUNICATION CO., LTD.

Building No.145 Lane 666, Xianing Rd.
Jinshan Industrial Zone, Jinshan District
ShangHai, China 201506

Tel: +86 21 60138638 Fax: +86 21 60138635-401

E-mail: ics@suntelecom.cn

<http://www.suntelecom.cn>

